

INSULATED MOUNTING HOLE  
(ACCOMODATES 1/4" HARDWARE)  
(2 PLCS)

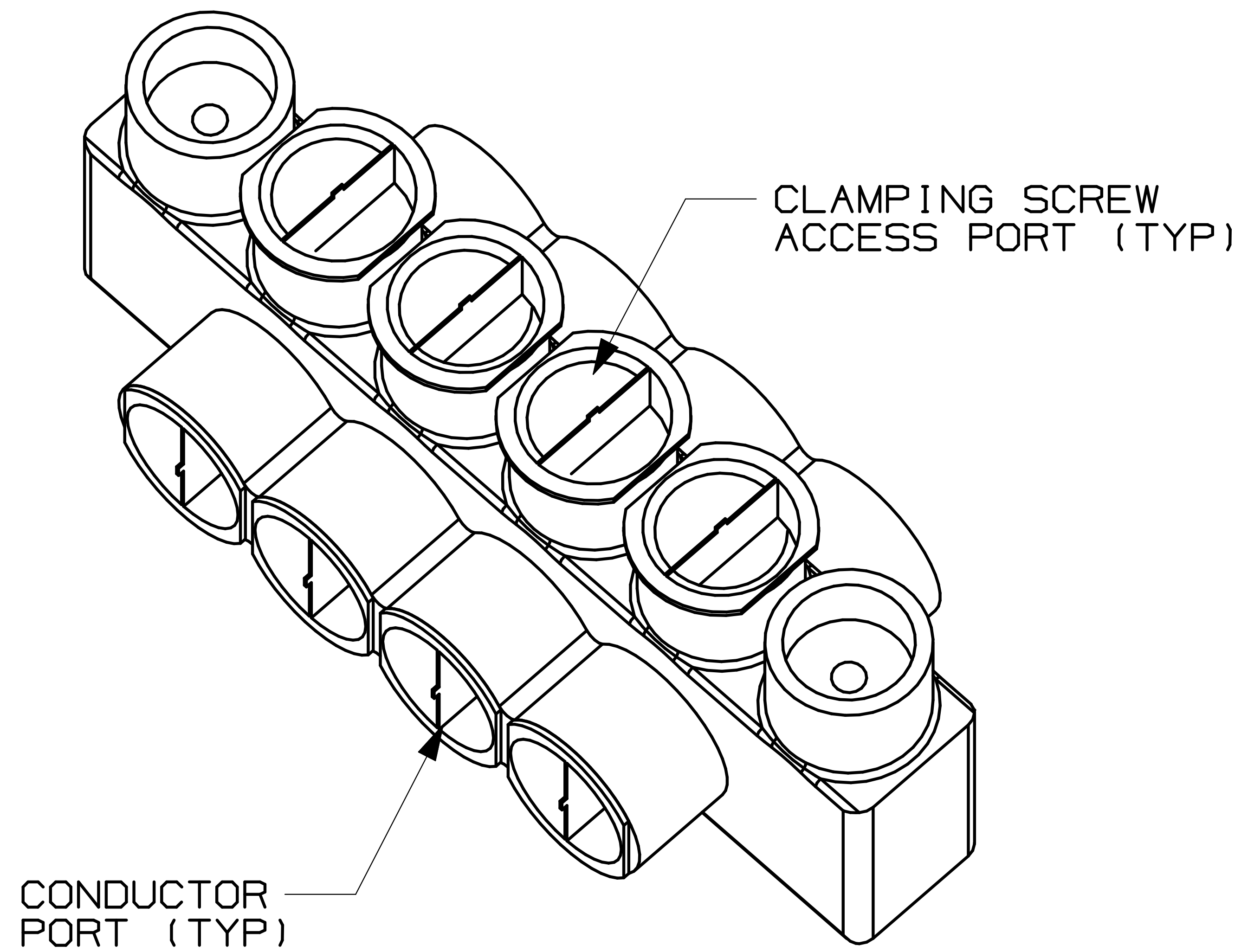
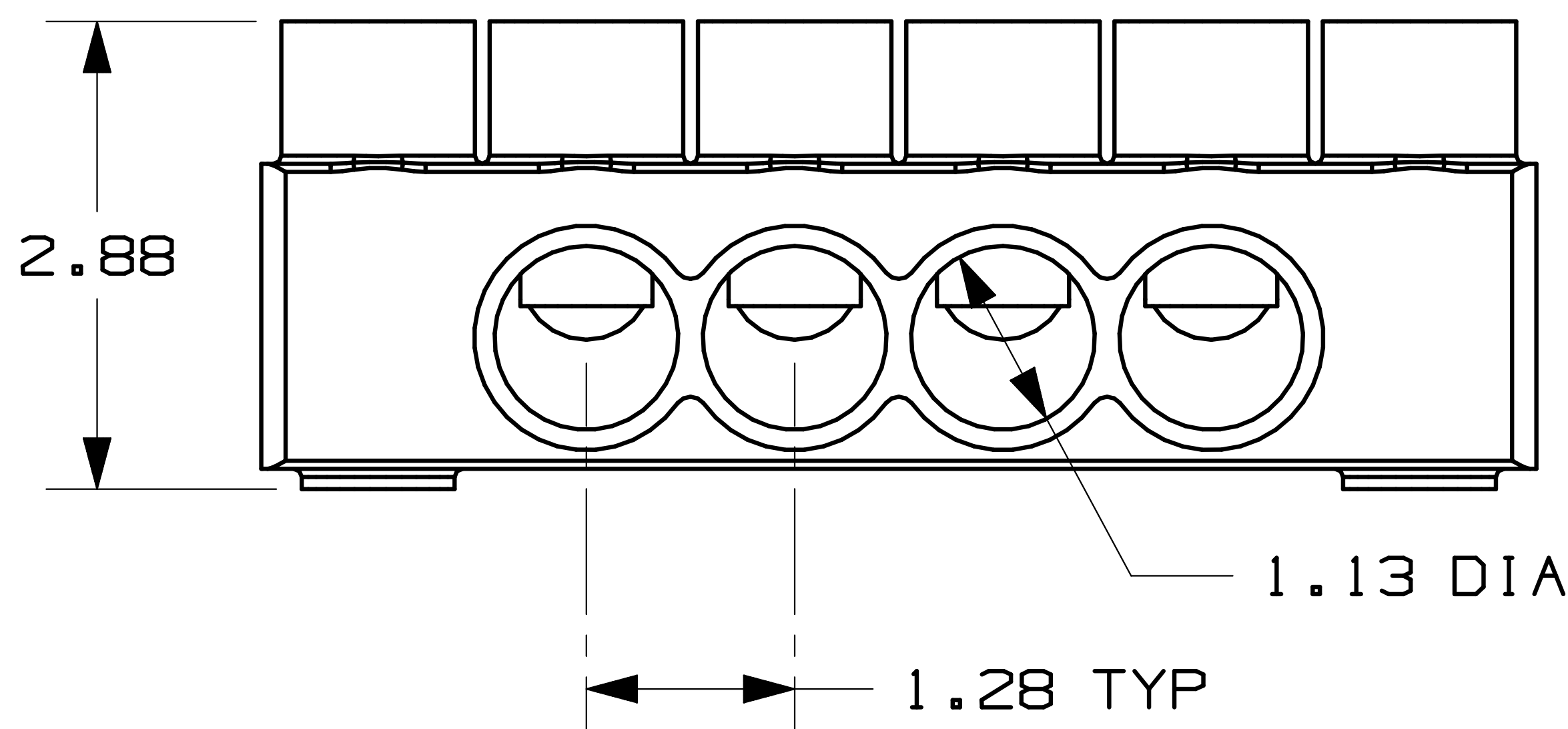
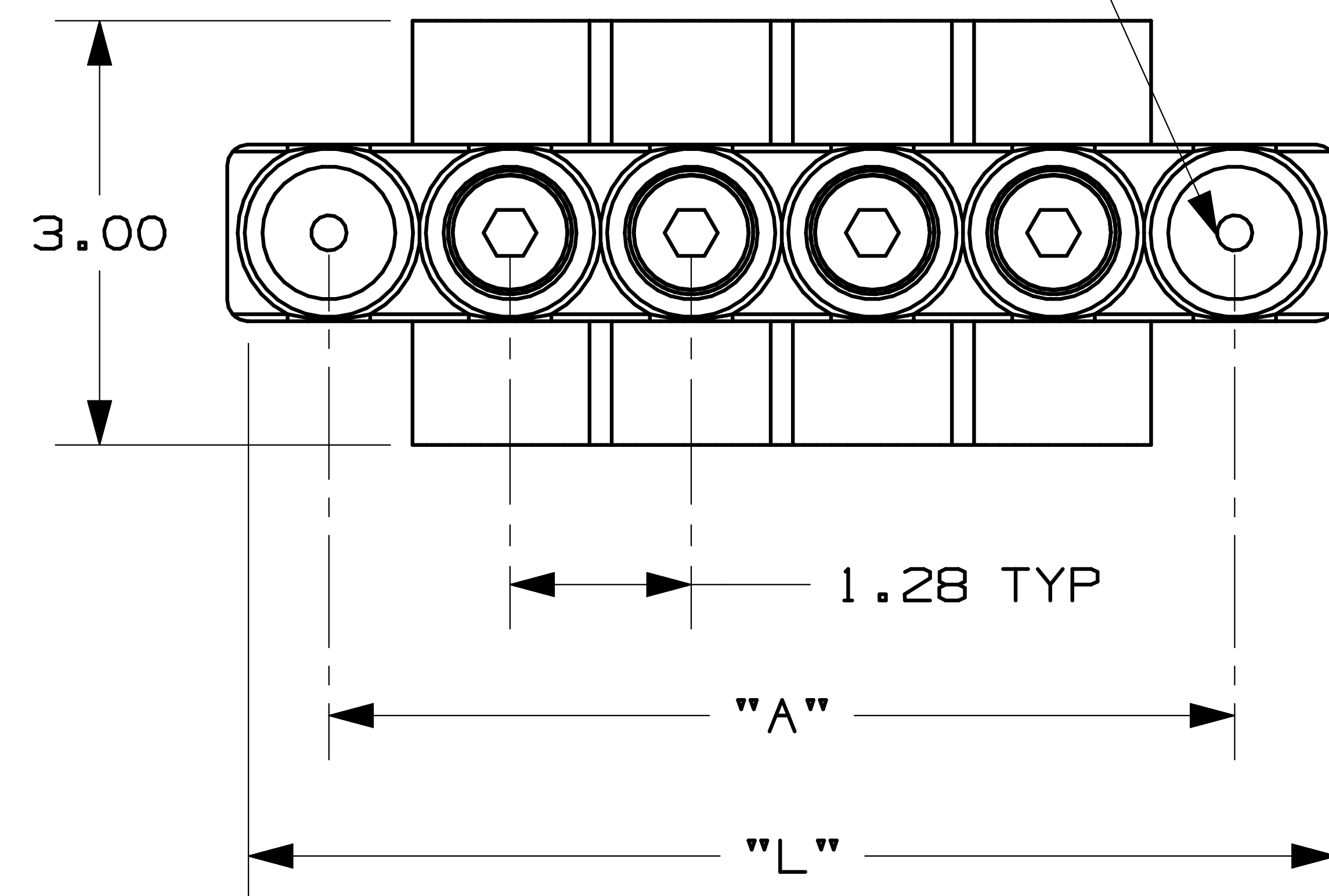

NOTES:

1. UL LISTED AND CSA CERTIFIED. DUAL RATED CU9AL FOR ALUMINUM OR COPPER CONDUCTORS. MEETS OR EXCEEDS ANSI C119.4
2. WIRE RANGE: 600 kcmil - #4 AWG. ONLY ONE CONDUCTOR PER PORT ALLOWED.
3. STRIP LENGTH: 1.06 +.06/-0
4. HEX KEY SIZE: 3/8", TIGHTENING TORQUE 375 IN-LB.
5. VOLTAGE RATING: 600 V. MAX.
6. TEMPERATURE RATING: 90° C.
7. CONNECTOR BLOCK BODY IS MADE FROM ALUMINUM. CLAMPING SCREWS ARE TIN PLATED. PORTS IN CONNECTOR BLOCK ARE PREFILLED WITH AN OXIDE-INHIBITING COMPOUND.
8. INSULATION MATERIAL IS CLEAR PVC.
9. CLAMPING SCREW ACCESS PORTS AND ALL CONDUCTOR ENTRY PORTS ARE PROVIDED WITH REMOVABLE PLASTIC CLOSURE PLUGS.
10. ALL DIMENSIONS SHOWN ARE NOMINAL.
11. PACKAGE QTY: -2 = 2 PCS  
-1 = 1 PCS
12. THIS PART IS ROHS COMPLIANT.

PART NUMBER	# CONDUCTOR PORTS	DIM "L"	DIM "A"
PCSBMT600-4-2Y	4	7.84	6.41
PCSBMT600-6-2Y	6	10.41	8.97
PCSBMT600-8-2Y	8	12.97	11.53
PCSBMT600-10-1Y	10	15.53	14.09
PCSBMT600-12-1Y	12	18.09	16.65

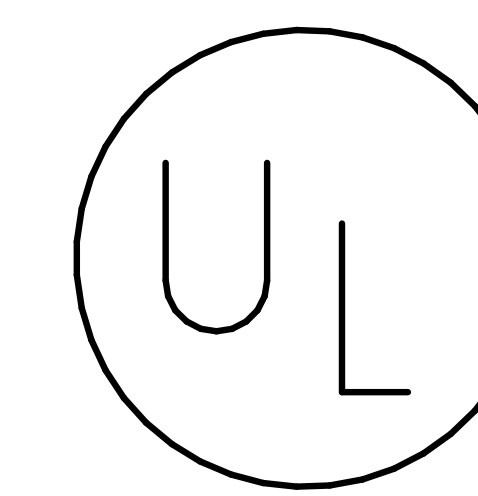

C41538\_00

**PANDUIT** CORP.

TINLEY PARK, ILLINOIS

MULTI-TAP INSULATED CONNECTORS  
WITH MOUNTING HOLES  
PCSBMT 600 DOUBLE SIDED SERIES

REV	DATE	BY	CHK	DESCRIPTION	ECN #	CUST	PM
00	3/06	JHNU	LEM	DRAWING RELEASED - ROHS COMPLIANT	PC00353		

DRAWN BY JHNU	CHK'D	SCALE N/A	DRAWING NO. C41538
------------------	-------	--------------	-----------------------